

Features

- **Noise Figure ≤ 3.8 dB Measured**
- Unconditionally Stable at all temperatures
- Internally Regulated DC Voltage
- 50 Ohm Matched Input/Output
- Field Replaceable SMA connectors
- Excellent Group Delay and Phase Linearity
- 0.009 inches diameter RF In/Out feed through
- 3 Year Warranty

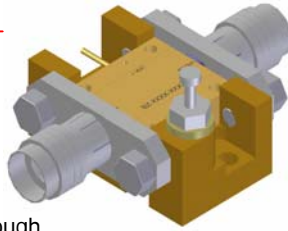

Specifications (23 °C)

Parameter	Min	Typ	Max	
Frequency Range	0.5	-	20	GHz
Noise Figure *			3.8	dB
Gain	15	16	-	dB
Gain Flatness	-		± 1.5	dB
P1dB Output Power**	17	18	-	dBm
Input VSWR	-	2.0:1	2.3:1	
Output VSWR	-	2.0:1	2.3:1	
Operating Temperature	-55	-	+85	°C
***Voltage	+14.5	-	+15.5	V
Current	-	175	190	mA

Options

- **Optimized Performance over Selected Bandwidth**
- Internally DC Block Input (Output DC Block Standard)
- Hermetically Sealed Package
- Gain and Phase matching
- Extended bandwidth to 100 MHz.
- Internal D.C. Voltage regulation

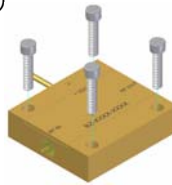

* Noise Source used for measurement: 0.1 – 18 GHz: HP346A, 18 – 20 GHz: HP346C
 Uncertainty of N.F. (approx. 0.12 dB) .10 db due to ENR of HP346C, .1 db due to Gain modulation of the amplifier.
 Noise Figures increase below 500 MHz
 **IMP: UNIT REQUIRES HEAT SINK.
 *** Input +15V with Internal D.C. voltage Regulation available

Performance Graphs

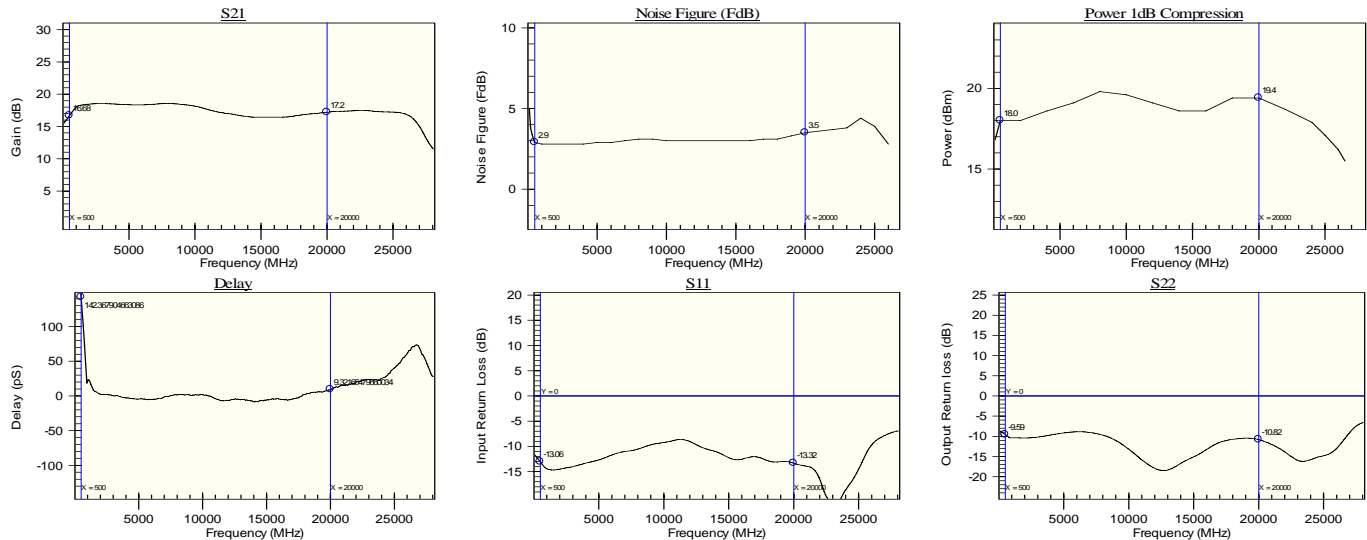

Outline Drawing

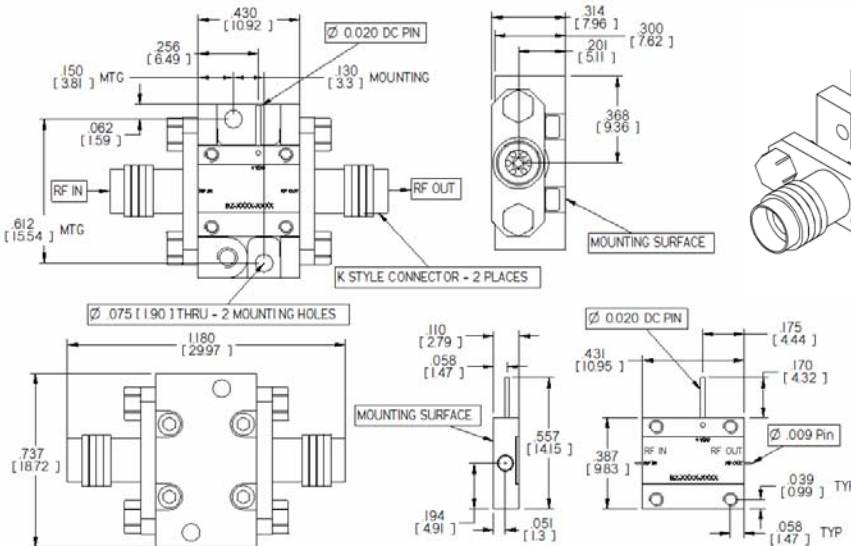

Mounting Drawing

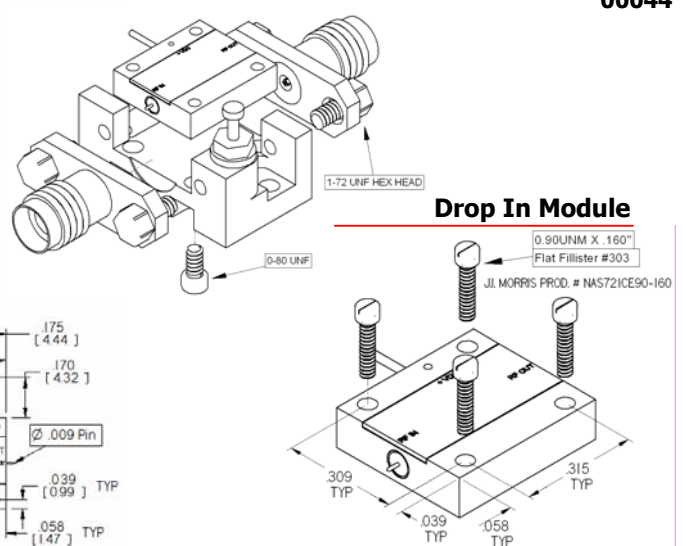

00044